

PS2-600 C-SJ3-9

Solar Submersible Pump System for 4" wells

System Overview

Head	max. 50 m
Flow rate	max. 4,1 m³/h

Technical Data

Controller PS2-600

- Controlling and monitoring
- Control inputs for dry running protection, remote control etc.
- Protected against reverse polarity, overload and overtemperature
- Integrated MPPT (Maximum Power Point Tracking)
- Battery operation: Integrated low voltage disconnect

Power	max. 0,70 kW
Input voltage	max. 150 V
Optimum Vmp**	> 68 V
Motor current	max. 13 A
Efficiency	max. 98 %
Ambient temp.	-40...50 °C
Enclosure class	IP68

Motor ECDRIVE 600-C

- Maintenance-free brushless DC motor
- Water filled
- Premium materials, stainless steel: AISI 304/316
- No electronics in the motor

Rated power	0,70 kW
Efficiency	max. 92 %
Motor speed	900...3.300 rpm
Insulation class	F
Enclosure class	IP68
Submersion	max. 150 m

Pump End PE C-SJ3-9

- Non-return valve
 - Premium materials, stainless steel: AISI 304
 - Centrifugal pump
- | | |
|------------|-----------|
| Efficiency | max. 53 % |
|------------|-----------|



Pump Unit PU600 C-SJ3-9 (Motor, Pump End)

Borehole diameter	min. 4,0 in
Water temperature	max. 50 °C

Standards



2006/42/EC, 2004/108/EC, 2006/95/EC

IEC/EN 61702:1995, IEC/EN 62253 Ed.1

The logos shown reflect the approvals that have been granted for this product family. Products are ordered and supplied with the approvals specific to the market requirements.

**Vmp: MPP-voltage under Standard Test Conditions (STC): 1000 W/m² solar irradiance, 25 °C cell temperature



PS2-600 C-SJ3-9

Solar Submersible Pump System for 4" wells

Pump Chart

Vmp* > 68 V

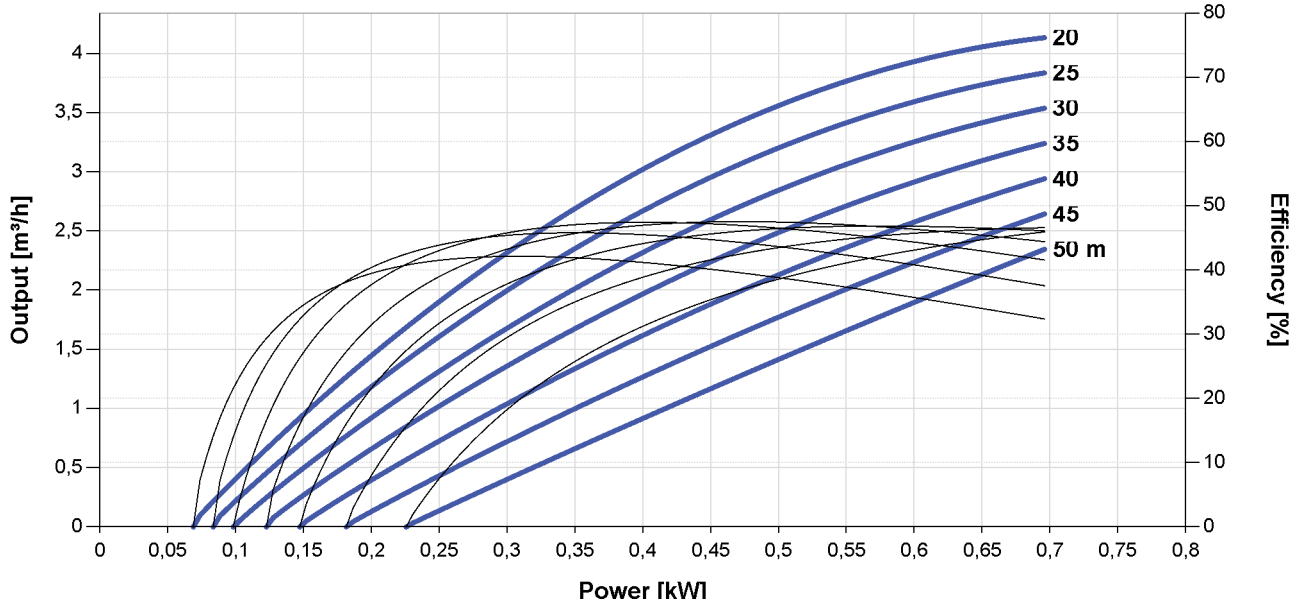

Dimensions and Weights

Controller

H1 = 352 mm
H2 = 333 mm
W1 = 207 mm
W2 = 170 mm
W3 = 164 mm
D1 = 124 mm

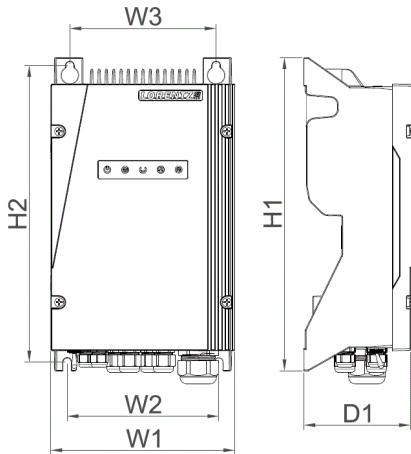

Pump Unit

A = 545 mm
B = 185 mm
C = 360 mm
D = 96 mm
E = 98 mm
S = 1,25 in

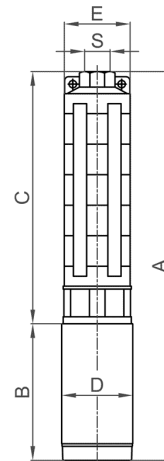

	Net weight
Controller	5,6 kg
Pump Unit	12 kg
Motor	7,0 kg
Pump End	4,5 kg

*Vmp: MPP-voltage under Standard Test Conditions (STC): 1000 W/m² solar irradiance, 25 °C cell temperature

